

安装开孔尺寸  
MOUNTING HOLE DIMENTION

t	X	Y
0.75-1.25	27.6 <sup>+0.1</sup>	21.5 <sup>+0.1</sup>
1.25-2.0	27.7 <sup>+0.1</sup>	21.5 <sup>+0.1</sup>
2.0-3.0	27.8 <sup>+0.1</sup>	21.5 <sup>+0.1</sup>

t为材料厚度  
Panel Thickness

电气原理图  
CIRCUIT DIAGRAM

ON-OFF

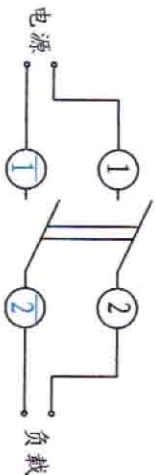

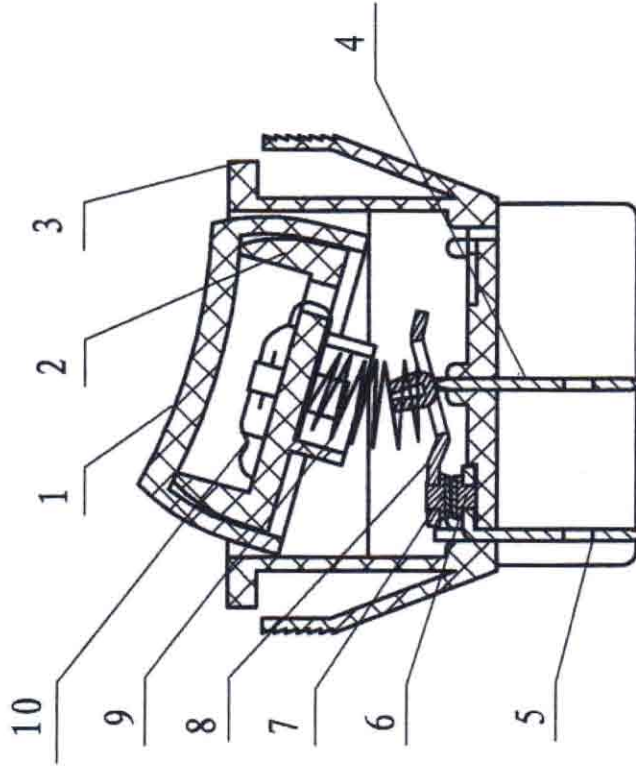

TOLERANCES UNLESS OTHERWISE 未指定容许尺寸公差	
BASIC DIMENSION TOLERANCES	
UP TO 10 (10以下)	±0.3
ABOVE 10 TO 100	±0.5
ABOVE 100 (100以上)	±0.8
ANGULAR DIMENSIONS (角度)	±3°

NINGBO MASTER SOKEN ELECTRICAL CO., LTD.	
DESIGNER	王友娟
CHECKED BY	
APPROVED BY	
DATE	2014.9.22
DATE	
DATE	
DIN UNIT	mm
TITLE	RK1-01 2X1 累丝板 "0-"
PAGE	



 NINGBO MASTER SOKEN ELECTRICAL CO., LTD.		DATE	2011.10.13	DIN UNIT	mm
DESIGNER	竺友朝	DATE	✓	TITLE	RK1-01-107RA/D0301BA
CHECKED BY	周幸福	DATE	10/31	PAGE	

# SPECIFICATION 规格书

1	Rating 额定值	16A 125VAC (UL); 16 (6) A 250VAC T100/55 (VDE); 16A 250VAC T100 (TUV, KEMA/ENEC); 16A 250VAC T100/55 (CQC); 16A 250VAC (K)						
2	Operating temperature range 使用环境温度	-25 ~ 85°C						
3	Operating force 动作力	9.0 ± 4.5N						
4	Marking 标记	The following is marked on the switch 开关上作如下标记						
		Manufacture's mark 商标						
		Catalogue No. 型号	RK1-01					
		Rating 额定值	16A 125VAC (UL); 16 (6) A 250VAC T100/55 (VDE); 16A 250VAC T100 (TUV, KEMA/ENEC); 16A 250VAC T100/55 (CQC); 16A 250VAC (K)					
		Lot. No 批号						
Approval mark 认证标记		     						
5	Approval No. 证书号	Approved	UL	VDE	TUV	CQC	KEMA/ENEC	K
		Catalogue NO. 证书类别	RK1-01	E218957	40012988	R500500670002	CQC03002003652	2006522.01
6	Applicable standard 适用标准		UL1054	IEC61058-1	IEC61058-1	GB15092.1-2010	IEC61058-1	61058-1 (2003)
7	Contact resistance 接触电阻	100mΩ Max.						
8	Insulation resistance 绝缘电阻	100MΩ Min.						
9	Voltage proof 耐压	端子间1500VAC 5S; 端子与接地间3000VAC 5S;						
10	Electric life 电气寿命	6000 cycles (16A 125VAC); 10000 cycles (16 (6) A 250VAC, 16A 250VAC)						
11	Neon tube Electric life 氖泡电气寿命	More than 10000 (250VAC) hours						

## MATERIAL LIST

No. 序号	Part name 零件名称	Description 材料名称	Quantity 数量	Note 说明
1	Cover (面罩)	PC	1	Ge. company
2	Holding (内托)	PA66	1	DUPONT DE NEMOUSR
3	Housing (底壳)	PA66	1	DUPONT DE NEMOUSR
4	Terminal (支架脚)	Copper alloy	2	H62 Y2 GB/T2059-2008
5	Contact (触点脚)	Copper alloy	2	H62 Y2 GB/T2059-2008
6	Static contact (静触点)	Silver alloy	2	
7	dynamic contact (动触点)	Silver alloy	2	
8	Dynamic flake (动触片)	Copper alloy	2	H62 Y2 GB/T2059-2008
9	Spring (弹簧)	Carbon steel wire	2	T9A GB4357-89
			1	Ge. company

宁波万事达综研电气有限公司 NINGBO MASTER SOKEN ELECTRICAL CO., LTD.	DESIGNER 设计	竺友朝	DATE 日期	2014. 9. 22	DIN UNIT 单位	mm
	CHECKED BY 审核		DATE 日期		TITLE 型号	RK1-01 2X1黑红纸 "0-"
	APPROVED BY 批准		DATE		DRAWING NO. 图号	

DOCUMENT NO 产品型号 RK1-01-107RA/D0301BA	TITLE 标题 PRODUCT SPECIFICATIONS 产品规格书	PAGE 页 1/6
------------------------------------------	---------------------------------------------	---------------

1. General 概述

- 1.1 Application 适用范围 / This specification is applied to power Switches used for electronic equipment.  
此规格书适用于电子设备上的电源开关。
- 1.2 Operating temperature rang 使用温度范围: -25~85℃
- 1.3 Test conditions 测试条件 Unless otherwise specified, the atmospheric conditions for making measurements and tests are as follows.  
除非另有规定, 否则进行测量与测试的大气条件为:  
Ambient temperature 环境温度: 5~35℃  
Relative humidity 相对湿度: 45~85%  
Air pressure 气压: 86~106 kpa ( 860~1060 mbar)  
Should any doubt arise in judgement, tests shall be conducted at the following conditions.  
若判断中出现争议, 则测试按以下条件进行:  
Ambient temperature 环境温度: 20±2℃  
Relative humidity 相对湿度: 60~70%  
Air pressure 气压: 86~106 kpa ( 860~1060 mbar)

2. Appearance, construction and dimensions 外观、结构和尺寸

- 2.1 Appearance 外观 Switch shall have good finishing, and no rust, crack or plating failures.  
开关应有良好的成形, 无锈蚀、裂纹和电镀剥落。
- 2.2 construction and dimensions 结构和尺寸 Refer to individual product drawing. 参见产品图

3. Ratings 额定值 16A 125VAC(UL);16(6)A 250VAC T100/55 (VDE); 16A.250VAC T100 (TUV.KEMA/ENEC); 16A 250VAC T100/55 (CQC); 16A 250VAC(K)

4. Electrical specification 电气规格

No. 序号	Items 项目	Test conditions 测试条件	Criteria 判定标准
4.1	Contact resistance 接触电阻	Shall be measured at 1A,5V DC by voltage drop method after some operations without load. 在无负载条件下, 操作数次后, 用电压降法, 以 1A,5V DC 进行测试。	100 mΩ max.
4.2	Insulation resistance 绝缘电阻	Test voltage: 500V DC, measured after 1min±5s Applied position: Between terminals . Between terminals and ground(frame) 测试条件: 500V DC, 1min±5s 测试位置: 在开路端子之间 在端子与接地外壳之间	100MΩ min.
4.3	Voltage proof 耐压	Following test voltages shall be applied for 1min. (Cut-off current:0.5mA) 1.Between terminals of open contacts: 1500V AC(50~60Hz) 2.Between terminals and ground(frame): 3000V AC(50~60Hz) 按以下测试电压进行 1 分钟。 (漏电流: 0.5mA) 1. 在开路端子之间: 1500V AC(50~60Hz) 2. 在端子与接地外壳之间: 3000V AC(50~60Hz)	No dielectric breakdown shall occur. 无击穿、飞弧现象

5. Mechanical specification 机械规格

No. 序号	Items 项目	Test conditions 测试条件	Criteria 判定标准
5.1 Operating features	Operating force 操作力	A static Load shall be applied to the tip of actuator in operating direction. 沿操作方向施加静负荷	9.0±4.5N

DOCUMENT NO 产品型号 RK1-01-107RA/D0301BA	TITLE 标题 PRODUCT SPECIFICATIONS 产品规格书	PAGE 页 2/6
------------------------------------------	---------------------------------------------	---------------

No. 序号	Items 项目	Test conditions 测试条件	Criteria 判定标准
5.2	Robusness of terminal 端子强度	A static Load of 98N shall be applied to the tip of terminal in a desired direction for 1 min.The test shall be done once per terminal. 98N 的静负荷将作用到端子顶部 1 分钟, 每个端子将测-次。	Shall be free from terminal looseness. damage and breakage of terminal holding portion. Terminals may be bent after test. Electrical performance requirement specified in item 4 shall be satisfied. 应无端子松动、损坏。测试后, 端子可能弯曲, 但应满足上面第 4 项中规定的电性能要求。
5.3	Vibration 振动	Switch shall be secured to a testing machine by a normal mounting device and method. Switch shall be measured after following test. 将开关正常安装在试验装置上, 按下例条件试验后进行测试。 (1) Vibration frequency range 振动频率范围: 10~55Hz (2) Total amplitude 全振幅 : 1.5mm (3) Sweep ratio 扫描比: 10~55~10 Hz Approx 约:1min (4) Method of changing the sweep vibration frequency: Logarhmic or linear. 改变扫描振动频率的方法: 对数或线性 (5) Direction of vibration : Three perpendicular directions including actuator. 振动方向: 面罩三个垂直方向 (6) Duration : 2h each (6h in total) 持续时间: 各 2 小时 (共 6 小时)	Switch shall function properly at rated current. 开关应通断正常 Insulation resistance 绝缘电阻(Item4.2): 10 MΩ min. Voltage proof 耐压(Item4.3): No dielectric breakdown shall occur. 无击穿、飞弧现象 Operating force 操作力(Item5.1): Within specified value. 在规定值之内 Shall be free from mechanical abnormalities. 无机械不正常
5.4	Shock 冲击	Switch shall be measured after following test. 按下例条件试验后进行测试。 (1) Mounting method :Normal mounting method 安装方法: 正常安装方法 (2) Acceleration 加速度: 490 m/s <sup>2</sup> (50G) (3) Duration 持续时间: 11ms (4) Test direction : 6 directions 测试方向 : 6 个方向 (5) Number of shocks : 3 times per direction (18 times in total) 冲击次数: 每个方向 3 次 (共 18 次)	Switch shall function properly at rated current. 开关应通断正常 Insulation resistance 绝缘电阻(Item4.2): 10 MΩ min. Voltage proof 耐压(Item4.3): No dielectric breakdown shall occur. 无击穿、飞弧现象 Operating force 操作力(Item5.1): Within specified value. 在规定值之内 Shall be free from mechanical abnormalities. 无机械不正常

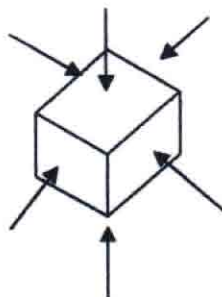

DOCUMENT NO 产品型号 RK1-01-107RA/D0301BA	TITLE 标题 PRODUCT SPECIFICATIONS 产品规格书	PAGE 页 3/6
------------------------------------------	---------------------------------------------	---------------

No. 序号	Items 项目	Test conditions 测试条件	Criteria 判定标准
--------	----------	----------------------	---------------

6.Durability 耐久性

6.1	Endurance (According to UL1054 standard ) 耐久性 (根据 UL1054 标准 )	<p>16A 125VAC</p> <p>Switch shall be operated according to following sequence. (Test1 → Test2) 开关应按以下顺序进行操作 (试验 1 → 试验 2)</p> <table border="1"> <thead> <tr> <th></th> <th>Voltage 电压</th> <th>Current 电流</th> <th>Power factor 功率因数</th> <th>Operation Rate 操作速率</th> <th>Number of Operation 操作次数</th> </tr> </thead> <tbody> <tr> <td>Test1 试验 1</td> <td>187.5VAC</td> <td>20A</td> <td>0.98~1.0</td> <td>6~10 cycles/min 次/分</td> <td>50cycles 次</td> </tr> <tr> <td>Test2 试验 2</td> <td>125VAC</td> <td>16A</td> <td>0.98~1.0</td> <td>6~10 cycles/min 次/分</td> <td>6000 cycles 次</td> </tr> </tbody> </table> <p>Temperature rise 温升 Difference between the steady terminal temperature and ambient temperature shall be measured after conducting the rated current. 温升即为开关接通额定电流, 稳定后的端子温度值与环境温度值之差。 Voltage proof (Cut-off current : 0.5mA) 耐压 (漏电流: 0.5mA) Following test voltages shall be applied for 1 分钟。 按以下测试电压进行 1 分钟。 Between terminals of open contacts 在开路端子之间: 1125V AC(50~60Hz) Between terminals and ground(frame) 在端子与接地外壳之间: 2250V AC(50~60Hz)</p>		Voltage 电压	Current 电流	Power factor 功率因数	Operation Rate 操作速率	Number of Operation 操作次数	Test1 试验 1	187.5VAC	20A	0.98~1.0	6~10 cycles/min 次/分	50cycles 次	Test2 试验 2	125VAC	16A	0.98~1.0	6~10 cycles/min 次/分	6000 cycles 次	<p>Switch shall function properly at rated current. 开关应通断正常 Insulation resistance 绝缘电阻 (Item4.2): 10 MΩ min. Voltage proof 耐压: No dielectric breakdown shall occur. 无击穿、飞弧现象 Operating force 操作力(Item5.1): Within +10,-30% of specified value. 在规定值的+10,-30%之内 Temperature rise 温升: 30°C max. No abnormalities shall be recognized in appearance and construction 外观和结构无异常</p>
			Voltage 电压	Current 电流	Power factor 功率因数	Operation Rate 操作速率	Number of Operation 操作次数														
Test1 试验 1	187.5VAC	20A	0.98~1.0	6~10 cycles/min 次/分	50cycles 次																
Test2 试验 2	125VAC	16A	0.98~1.0	6~10 cycles/min 次/分	6000 cycles 次																

DOCUMENT NO 产品型号 RK1-01-107RA/D0301BA	TITLE 标题 PRODUCT SPECIFICATIONS 产品规格书	PAGE 页 4/6
------------------------------------------	---------------------------------------------	---------------

No. 序号	Items 项目	Test conditions 测试条件	Criteria 判定标准												
6.2	Endurance (According to IEC61058-1 standard ) 耐久性 (根据 IEC61058-1 标准 )	<p>16 (6) A 250VAC Switch shall be operated 10,000 cycles at 15~20 cycles/min. 开关应能承受 15~20 次/分钟的速率 10,000 次操作。</p> <table border="1" style="margin-left: 20px;"> <thead> <tr> <th>Operate 操作</th> <th>Voltage 电压</th> <th>Current 电流</th> <th>Power factor 功率因数</th> </tr> </thead> <tbody> <tr> <td>ON 接通</td> <td>250v</td> <td>6×6A</td> <td>0.6</td> </tr> <tr> <td>OFF 断开</td> <td>250v</td> <td>16A</td> <td>0.95</td> </tr> </tbody> </table> <p>Temperature rise 温升 Difference between the steady terminal temperature and ambient temperature shall be measured after conducting the rated current. 温升即为开关接通额定电流，稳定后的端子温度值与环境温度值之差。 Voltage proof (Cut-off current :0.5mA) 耐压 (漏电流: 0.5mA) Following test voltages shall be applied for 1 分钟。 按以下测试电压进行 1 分钟。 Between terminals of open contacts 在开路端子之间: 1125V AC(50~60Hz) Between terminals and ground(frame) 在端子与接地外壳之间: 2250V AC(50~60Hz)</p>	Operate 操作	Voltage 电压	Current 电流	Power factor 功率因数	ON 接通	250v	6×6A	0.6	OFF 断开	250v	16A	0.95	<p>Switch shall function properly at rated current. 开关应通断正常 Insulation resistance 绝缘电阻 (Item4.2): 10 MΩ min. Voltage proof 耐压: No dielectric breakdown shall occur. 无击穿、飞弧现象 Operating force 操作力(Item5.1): Within +10,-30% of specified value. 在规定值的+10,-30%之内 Temperature rise 温升: 55℃ max. No abnormalities shall be recognized in appearance and construction 外观和结构无异常</p>
Operate 操作	Voltage 电压	Current 电流	Power factor 功率因数												
ON 接通	250v	6×6A	0.6												
OFF 断开	250v	16A	0.95												

No. 序号	Items 项目	Test conditions 测试条件	Criteria 判定标准
--------	----------	----------------------	---------------

7.Environmental 耐候性			
7.1	Cold 耐寒性	<p>After testing at -25℃ for 16h,the switch shall be allowed to stand under normal room temperature and humidity condition for 1h,and then measurement shall be made within 1h,Water drops shall be removed. 将开关置于-25℃内 16h 以后，再置于常温、常湿中 1h，除去水滴后，在 1h 内测定之。 Voltage proof (Cut-off current : 0.5mA) 耐压 (漏电流: 0.5mA) Following test voltages shall be applied for 1 分钟。 按以下测试电压进行 1 分钟。 Between terminals of open contacts 在开路端子之间: 1125V AC(50~60Hz) Between terminals and ground(frame) 在端子与接地外壳之间: 2250V AC(50~60Hz)</p>	<p>Switch shall function properly at rated current. 开关应通断正常 Insulation resistance 绝缘电阻 (Item4.2): 10 MΩ min. Voltage proof 耐压: No dielectric breakdown shall occur. 无击穿、飞弧现象 Operating force 操作力(Item5.1): Within +10,-30% of specified value. 在规定值的+10,-30%之内 No abnormalities shall be recognized in appearance and construction. 外观和结构无异常</p>

DOCUMENT NO 产品型号 RK1-01-107RA/D0301BA	TITLE 标题 PRODUCT SPECIFICATIONS 产品规格书	PAGE 页 5/6
------------------------------------------	---------------------------------------------	---------------

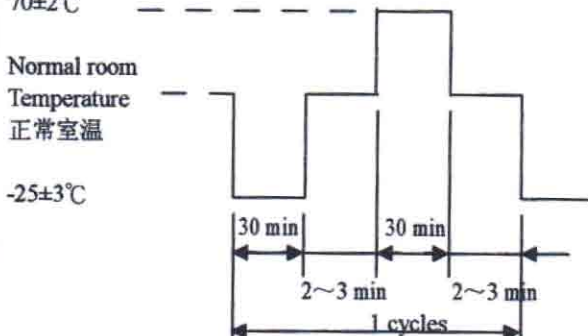
No. 序号	Items 项目	Test conditions 测试条件	Criteria 判定标准
7.2	Dry heat 耐热性	<p>After testing at 85±2℃ for 16h,the switch shall be allowed to stand under normal room temperature and humidity condition for 1h,and then measurement shall be made within 1h. 将开关置于 85±2℃ 内 16h 以后,再置于常温、常湿中 1h,在 1h 内测定之。</p> <p>Voltage proof (Cut-off current : 0.5mA) 耐压 (漏电流: 0.5mA) Following test voltages shall be applied for 1 分钟。 按以下测试电压进行 1 分钟。</p> <p>Between terminals of open contacts 在开路端子之间: 1125V AC(50~60Hz) Between terminals and ground(frame) 在端子与接地外壳之间: 2250V AC(50~60Hz)</p>	<p>Switch shall function properly at rated current. 开关应通断正常</p> <p>Insulation resistance 绝缘电阻(Item4.2): 10 MΩ min.</p> <p>Voltage proof 耐压: No dielectric breakdown shall occur. 无击穿、飞弧现象</p> <p>Operating force 操作力(Item5.1): Within +10,-30% of specified value. 在规定值的+10,-30%之内</p> <p>No abnormalities shall be recognized in appearance and construction. 外观和结构无异常</p>
7.3	Damp heat 耐湿性	<p>After testing at 40±2℃ and 90~95%RH for 96h,the switch shall be allowed to stand under normal room temperature and humidity condition for 1h,and then measurement shall be made within 1h,Water drops shall be removed. 将开关置于 40±2℃ ,相对湿度 90~95%内 96h 以后,再置于常温、常湿中 1h,除去水滴后,在 1h 内测定之。</p> <p>Voltage proof (Cut-off current : 0.5mA) 耐压 (漏电流: 0.5mA) Following test voltages shall be applied for 1 分钟。 按以下测试电压进行 1 分钟。</p> <p>Between terminals of open contacts 在开路端子之间: 1125V AC(50~60Hz) Between terminals and ground(frame) 在端子与接地外壳之间: 2250V AC(50~60Hz)</p>	<p>Switch shall function properly at rated current. 开关应通断正常</p> <p>Insulation resistance 绝缘电阻(Item4.2): 10 MΩ min.</p> <p>Voltage proof 耐压: No dielectric breakdown shall occur. 无击穿、飞弧现象</p> <p>Operating force 操作力(Item5.1): Within +10,-30% of specified value. 在规定值的+10,-30%之内</p> <p>No abnormalities shall be recognized in appearance and construction. 外观和结构无异常</p>
7.4	Change of temperature 温度急变	<p>After 5 cycles of following conditions the switch shall be allowed to stand under normal room temperature and humidity condition for 1h,and then measurement shall be made within 1h after that,Water drops shall be removed. 实施如下 5 次温度循环试验后,再置于常温、常湿中 1h,除去水滴后,在 1h 内测定之。</p> <p>70±2℃</p>  <p>Normal room Temperature 正常室温</p> <p>-25±3℃</p> <p>30 min 30 min 2~3 min 2~3 min</p> <p>1 cycles</p> <p>Voltage proof (Cut-off current : 0.5mA) 耐压 (漏电流: 0.5mA) Following test voltages shall be applied for 1 分钟。 按以下测试电压进行 1 分钟。</p> <p>Between terminals of open contacts 在开路端子之间: 1125V AC(50~60Hz) Between terminals and ground(frame) 在端子与接地外壳之间: 2250V AC(50~60Hz)</p>	<p>Switch shall function properly at rated current. 开关应通断正常</p> <p>Insulation resistance 绝缘电阻(Item4.2): 10 MΩ min.</p> <p>Voltage proof 耐压: No dielectric breakdown shall occur. 无击穿、飞弧现象</p> <p>Operating force 操作力(Item5.1): Within +10,-30% of specified value. 在规定值的+10,-30%之内</p> <p>No abnormalities shall be recognized in appearance and construction. 外观和结构无异常</p>



DOCUMENT NO 产品型号 RK1-01-107RA/D0301BA	TITLE 标题 PRODUCT SPECIFICATIONS 产品规格书	PAGE 页 6/6
------------------------------------------	---------------------------------------------	---------------

No. 序号	Items 项目	Test conditions 测试条件	Criteria 判定标准
7.5	Salt mist 盐雾	<p>Switch shall be checked after following test.</p> <p>(1)Temperature: 35±2℃ (2)Salt solution: 5±1%(solids by mass) (3)Duration: 24±1h</p> <p>After test, salt deposit shall be removed in running water. 按下例条件试验后进行测试。</p> <p>(1)温度: 35±2℃ (2)盐溶液: 5±1%(固状) (3)持续时间: 24±1h</p> <p>试验后,用流水洗净盐份。</p>	<p>No remarkable corrosion shall be recognized in metal part. 金属部分无锈蚀</p>